

FURUNO

MODEL

SCX-20/21

SATELLITE COMPASS™

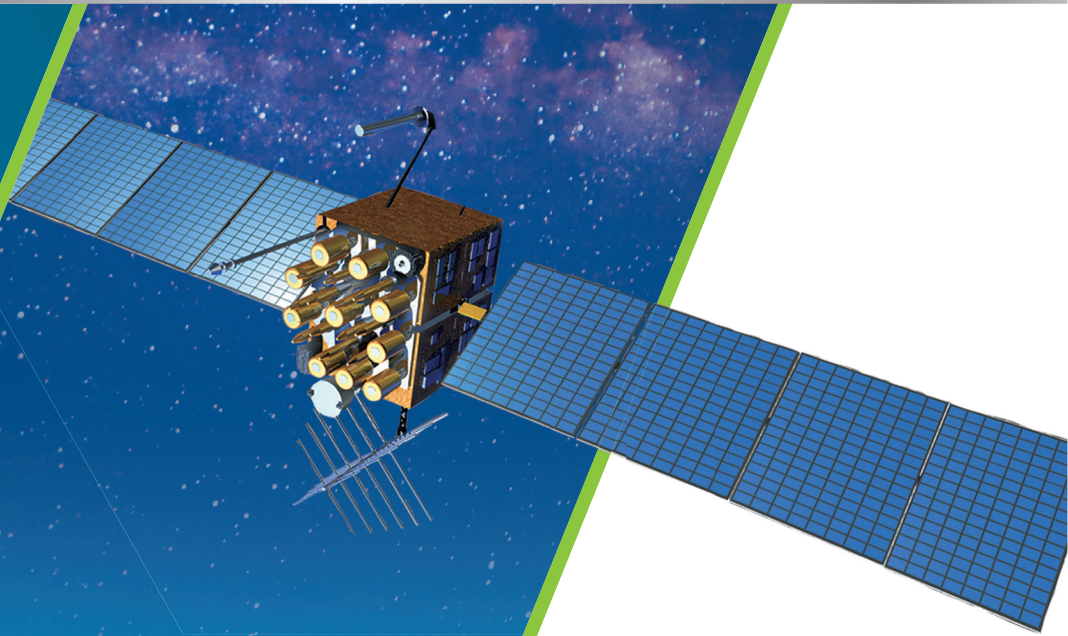

SCX-20
NMEA2000

SCX-21
NMEA0183



SCX-20 ONLY



www.furuno.com

AMAZING MULTI-GNSS SATELLITE COMPASS™

RELIABLE ACCURACY IN THE MOST CHALLENGING SITUATIONS

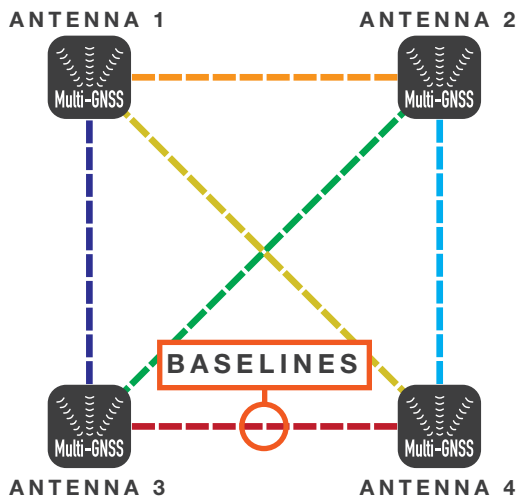

The SCX-20 and SCX-21 are designed with simplicity in mind and can be mounted virtually anywhere on the vessel.

Utilizing four separate GNSS Antennas for the ultimate in responsiveness, the SCX-20 and SCX-21 set a new standard for reliable and accurate heading for all of your marine electronics. Traditionally, a Satellite Compass™ calculates heading using one baseline between two antennas; the SCX-20/21's four antennas can calculate heading information using any one of the six baselines drawn between the four antennas.

The unprecedented quad-antenna design of the SCX-20 and SCX-21 makes them capable of calculating extremely accurate heading, pitch, roll, and heave information. They are the perfect heading solution for complex vessel installations where the view of satellites may sometimes be obstructed.



The SCX-20 is a perfect companion unit for the NAVpilot-300.



Connect the SCX-20 to NavNet TZtouch MFD's for highly accurate heading data!

EXPERIENCE SUPERIOR ACCURACY

The SCX-20 and SCX-21 enhance the performance of on-board equipment such as Radar, Fish Finders, Sonar, and Autopilots. Accurate heading information empowers your NAVpilot to keep a better course, saving time, fuel, and money on every voyage; meanwhile, precise pitch, roll, and heave information stabilizes the display for many Furuno Fish Finders and Sonars, allowing for an accurate presentation even in the roughest of seas.

RADAR/PLOTTER

True echo trails are available when the SCX-20 or SCX-21 is connected to your Furuno Radar, helping to determine own ship's movement as well as the movement of other vessels. Accurate speed and heading data ensures that target trails are displayed smoothly and accurately, without the jagged, zig-zag appearance common to compasses with a higher degree of deviation.

TRUE MOTION TARGET TRAILS

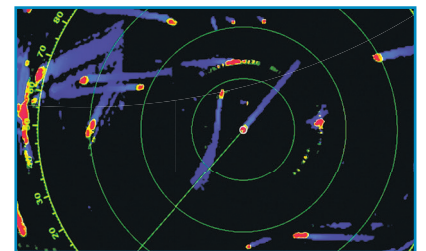

FISH FINDER

Even in heavy seas, accurate heave compensation from SCX-20 or SCX-21 enable Fish Finders such as the FCV-1150 or NavNet TZtouch/TZtouch2/TZtouch3 to show you an unwavering presentation of the seabed, without the undulations caused by sea conditions.

HEAVING COMPENSATION

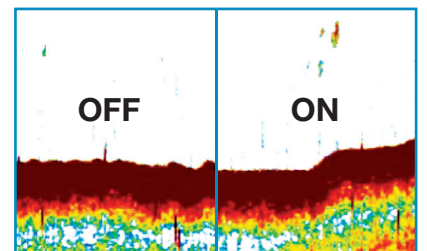

SONAR

Accurate pitch and roll information allows Furuno Sonar systems to display a steady image on the screen, even in foul weather.

PITCH & ROLL COMPENSATION

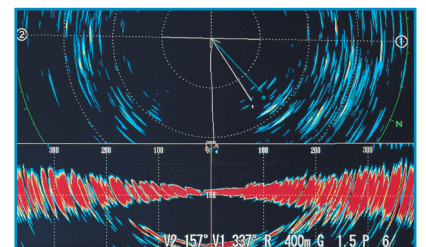

RADAR ECHO TRAIL ZIG-ZAG DOMINATION

TESTED. PROVEN. SUPERIOR.

When connected to Furuno SCX-20/21, the Radar's echo trails hold steady and clearly depict an accurate echo trail thanks to the SCX-20/21's amazing accuracy.

FURUNO SCX-20/21

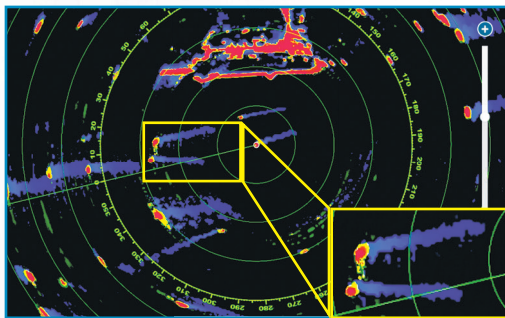

Company A

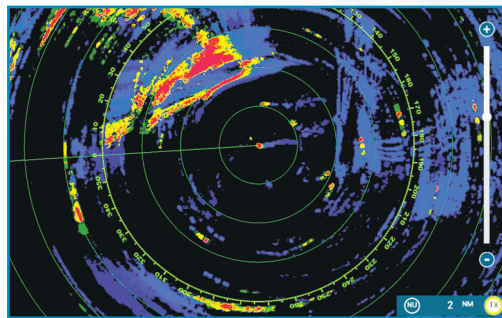

Company A's satellite compass fails to uphold a steady heading, making echo trails virtually unintelligible.

Company B's heading accuracy fluctuates by +/- 3° with a slower update, causing an echo trail that has a wide zig-zag pattern.

Company B

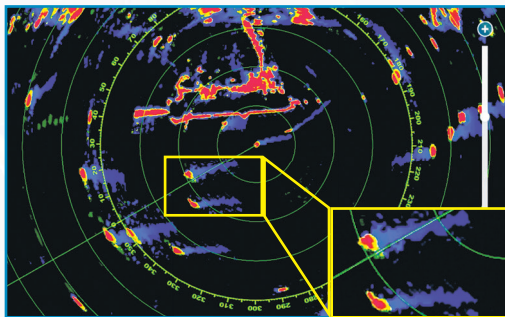

Company C

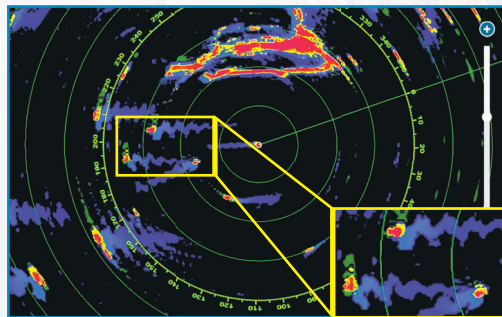

Company C's heading accuracy fluctuates by +/- 5° with a faster update, causing an echo trail that is indistinguishable and confusing.

MORE ACCURATE

SCX-20/21 < COMPANY B < COMPANY C < COMPANY A

LESS ACCURATE

RELAY CRITICAL DATA

Effortlessly connect with existing Furuno systems in order to elevate your awareness of own vessel and the surrounding area by displaying critical information across several products including NavNet TZtouch MFD's, NAVpilot-300, FI-70, and GP-39! Initial setup can be done from NavNet series MFD, NAVpilot-300 and GP-39.

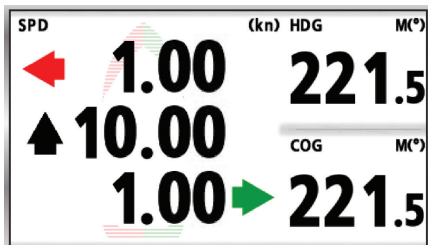

- 3-Axis Speed
- Pitch, Roll, Heave
- Rate of Turn (RoT)
- Heading (HDG)

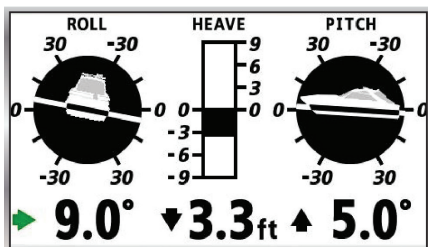

GP-39

FI-70

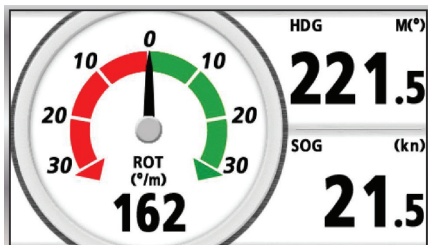

SCX-20/21

SATELLITE COMPASS™

- Perfect for NavNet TZtouch MFD, NAVpilot-300, and WASSP installations
- Outputs accurate Time, Position, Heading, COG/SOG, ROT, Roll/Pitch/Heave 3-Axis Speed, Air Temperature and Air Pressure data
- Unprecedented heading accuracy for Radars, Sonars, and Navigation
- Utilizes four Multi GNSS (GPS, QZSS, GLONASS, Galileo) antennas
- 1.0 degree heading accuracy, 0.02 knot speed accuracy
- Lightweight antenna - only 1.0kg!

FURUNO SCX-20/21

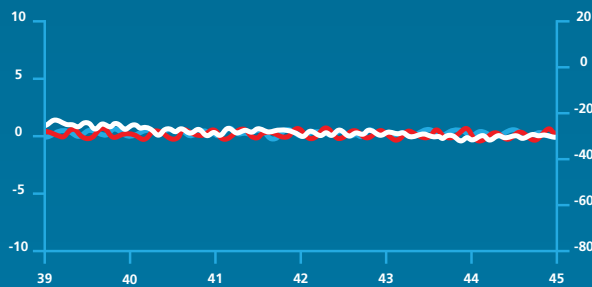

HEADING DEVIATION
ROLL
PITCH
y = Standard Deviation (deg)
x = Time (sec)

COMPANY A

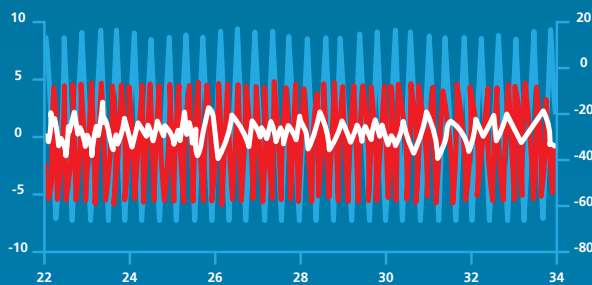

COMPANY B

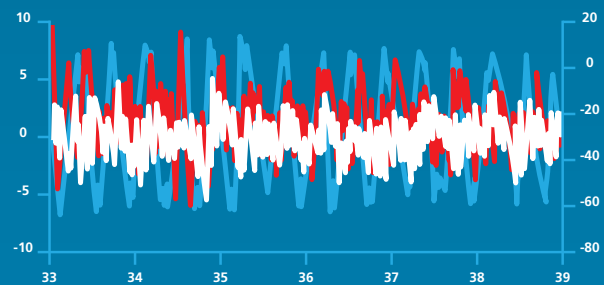

Test Conditions:

Roll - Amplitude 20°, 10 sec. period

Pitch - Amplitude 10°, 6 sec. period

Heading - 5°, 15 sec. period

Standard - ISO22090-3 (2015)



SCX-20
NMEA2000



SCX-21
NMEA0183

GENERAL

Frequency	1575.42 MHz (GPS/Galileo/QZSS/SBAS) 1602.5625 MHz (GLONASS)
Tracking Code	C/A (GPS/QZSS/SBAS), E1B (Galileo), L10F (GLONASS)
Attitude	Heading/Roll/Pitch: 1.0° rms (static) 0.5° rms (dynamic)
Follow Up	45°/sec
Heave Accuracy	σ5cm
Timing	(1PPS Accuracy: 50µs (SCX-21 only)
Settling Time	60 seconds approx.
Position Accuracy	
GPS:	5m approx. (2 drms, HDOP < 4)
MSAS:	4m approx. (2 drms, HDOP < 4)
WAAS:	3m approx. (2 drms, HDOP < 4)
Position Fix Time	50 seconds approx.
Update Interval	
Attitude:	50 Hz MAX
Position:	10 Hz MAX
Ship Speed Accuracy	
SOG:	0.02 kn rms (tracking satellites 5 or more) 0.2 kn rms (tracking satellites 3 or more)
VBW:	0.02 kn rms (tracking satellites 5 or more, at antenna position) 0.08 kn rms (tracking satellites 5 or more, at another position) 2.0% of ship's speed or 0.2 kn, whichever is greater (tracking satellites 3 or 4)
Pressure	850 to 1100 hPa (temp range: 0°C to > 50°C), ± 1.0 hPa (offset adjustment)
Temperature	-20°C to > 55°C (relative wind: ≥ 4 kn), ± 2.0°C (offset adjustment)

POWER SUPPLY

Standard: 12-24 VDC: 0.2-0.1 A (4 LEN @ 9 VDC)

INTERFACE

Ports	
SCX-20:	1 Port NMEA2000
Input	059392/904, 060160/416/928, 061184, 065240, 126208/720, 130847
Output	059392/904, 060928, 061184, 065280, 126208/464/720/992/993/996/998, 127250/251/252/257/258, 129025/026/029/538/539/540, 130310/312/314/316/577/578/816/817/818/819/822/823, 130833/834/842/843/845/846/847
SCX-21:	3 Ports NMEA0183, Tx 3 Ch, Rx 2 Ch 1 Port PPS, RS-485, rising edge detecting

Data Sentences	
Input:	AAM*, APB*, BOD*, BWC*, BWR*, RMB*, TLL*, XDR, XTE*
Output:	AAM*, APB*, BOD*, BWR*, DTM, GGA, GLL, GNS, GSA, GSV, HDG, HDT, HRM, POS, RMB*, RMC, ROT, THS, TLL*, VBW, VTG, XTE*, ZDA GPatt, Gphve, GPimu, pidat, SDmrk*, GPmsv, hdcom
P Sentences	*: GP-39 REQUIRED

ENVIRONMENTAL CONDITIONS

Ambient Temperature:	-25°C to +55°C (storage: -30°C to 70°C)
Relative Humidity:	95% or less at +40°C
Degree of Protection:	IP56

EQUIPMENT

Cable Assembly	SCX-20: FRU-NMEA-PMMFF cable (6m) SCX-21: FRU-CF-F cable (15m) SCX-20: Roof or Pole Mount SCX-21: Pole Mount ONLY
Standard	SCX-21: Pole Mount ONLY
Optional Supply	Installation materials, spare parts
Interface Unit:	SCX-20: FI-70 SCX-21: GP-39

INTERCONNECTION DIAGRAM

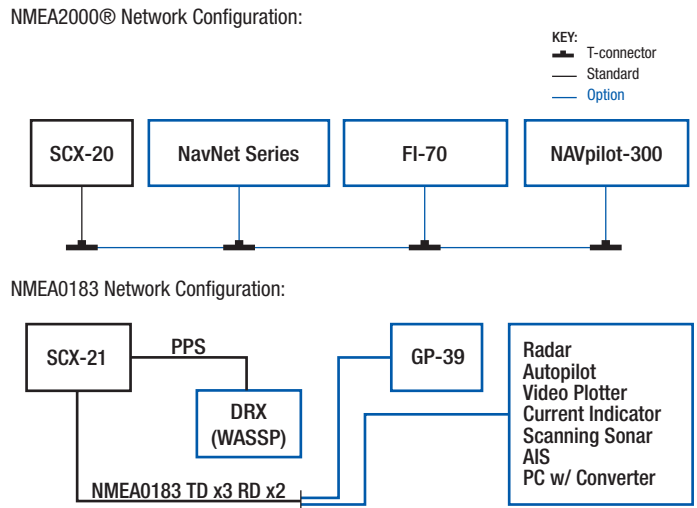

UNIT DIAGRAMS

SCX-20 w/ roof mount
1.4 kg (3.0 lbs)

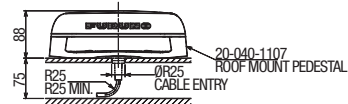
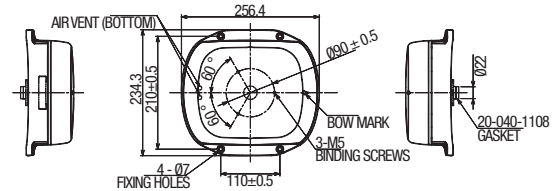

SCX-20 w/o mount
1.0 kg (2.2 lbs)

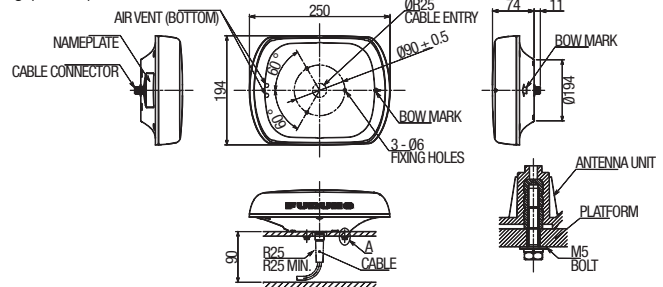

DETAIL FOR A (SCALE: 1/1)

SCX-20/21 w/ pole mount
1.2 kg (2.64 lbs)

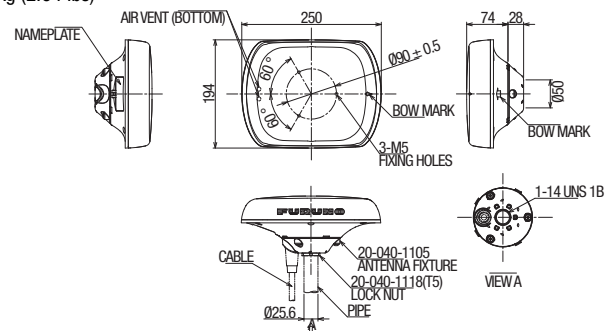

Catalog No. 1-A-19113SK
CA00001393

FURUNO ELECTRIC CO., LTD.

Japan www.furuno.com
FURUNO U.S.A., INC.
 U.S.A. www.furunousa.com
FURUNO PANAMA S.A.
 Republic of Panama www.furuno.com.pa
FURUNO (UK) LIMITED
 U.K. www.furuno.co.uk
FURUNO NORGE A/S
 Norway www.furuno.no

FURUNO DANMARK A/S

Denmark www.furuno.dk
FURUNO SVERIGE AB
 Sweden www.furuno.se
FURUNO FINLAND OY
 Finland www.furuno.fi
FURUNO POLSKA Sp. z o.o.
 Poland www.furuno.pl
FURUNO DEUTSCHLAND GmbH
 Germany www.furuno.de

FURUNO FRANCE S.A.S.

France www.furuno.fr
FURUNO ESPAÑA S.A.
 Spain www.furuno.es
FURUNO ITALIA S.R.L.
 Italy www.furuno.it
FURUNO HELLAS S.A.
 Greece www.furuno.gr
FURUNO (CYPRUS) LTD
 Cyprus www.furuno.com.cy

FURUNO EURUS LLC

Russian Federation www.furuno.ru
FURUNO SHANGHAI CO., LTD.
 China www.furuno.com/cn
FURUNO CHINA CO., LTD.
 Hong Kong www.furuno.com/cn
FURUNO KOREA CO., LTD
 Korea
FURUNO SINGAPORE
 Singapore www.furuno.sg

PT FURUNO ELECTRIC INDONESIA

Indonesia www.furuno.id
FURUNO ELECTRIC (MALAYSIA) SDN. BHD.
 Malaysia www.furuno.com/my
BEWARE OF SIMILAR PRODUCTS
 All brand and product names are trademarks, registered trademarks, or service marks for their respective holders.
SPECIFICATIONS SUBJECT TO CHANGE WITHOUT NOTICE
 Printed in U.S.A.